

# Top 1% Sign Technology

**FLEX-AMERICA**

Color Changing Channel Letter  
Block Channel Letter Signs

## Seeing is Believing

### Newest Creative Sign Technology

Metallic Coated Letters Translucent and Opaque

Metallic Color Changing Illuminated Letters

Neon Style Curved Acrylic Illuminated Letters

Micro Thin(1/8") Illuminated Block Letters

Stainless Steel Micro Perforated Letter Light



# Front Lit

1.18" (30mm)  
Block Acrylic  
- CNC routed &  
LED embedded

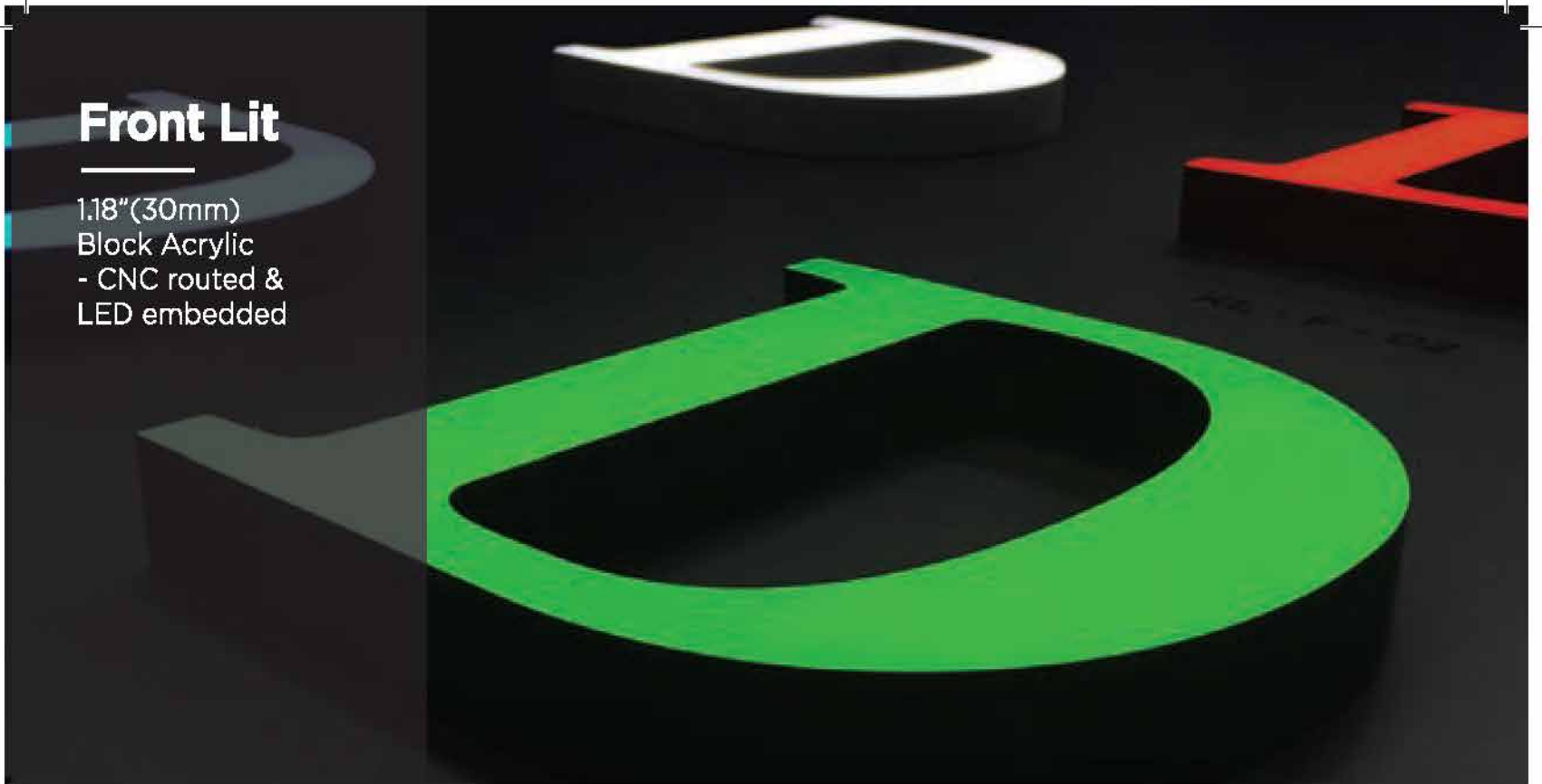

## Customized Color



## Light Color

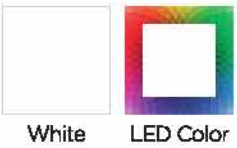

KL - F - 01

Daytime

Nighttime



KL - F - 02

Daytime

Nighttime



KL - F - 03

Daytime

Nighttime



KL - F - 04

Daytime

Nighttime

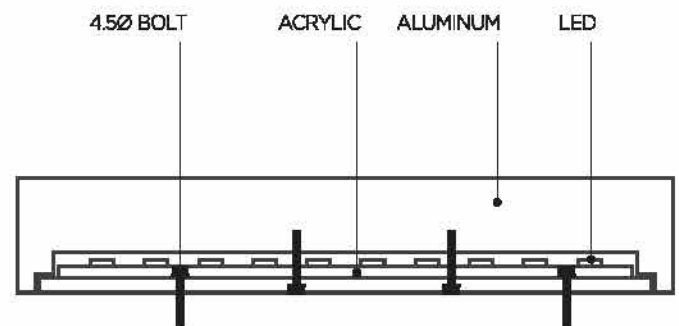
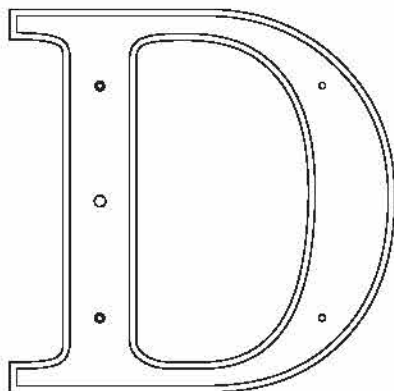

[Section Plan]

# Reverse & Side Lit

Special Metallic  
coated letters



Surface Material



Light Color

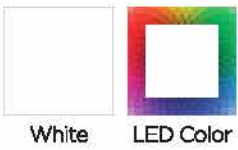

**KL - RS - 01**

Daytime



Nighttime



**KL - RS - 02**

Daytime



Nighttime

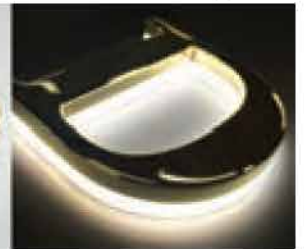

**KL - RS - 03**

Daytime



Nighttime



**KL - RS - 04**

Daytime



Nighttime

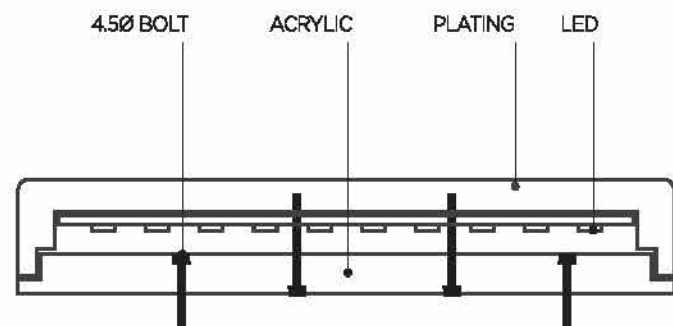
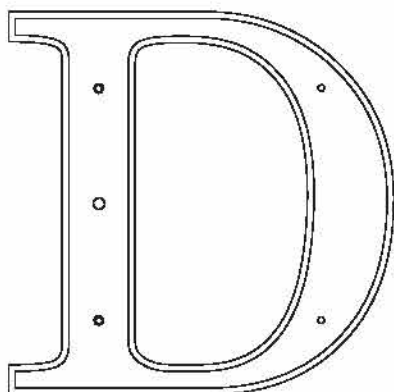

[Section Plan]

# Special Front Light

Laminated Specialty Acrylic  
- CNC routed & LED embedded

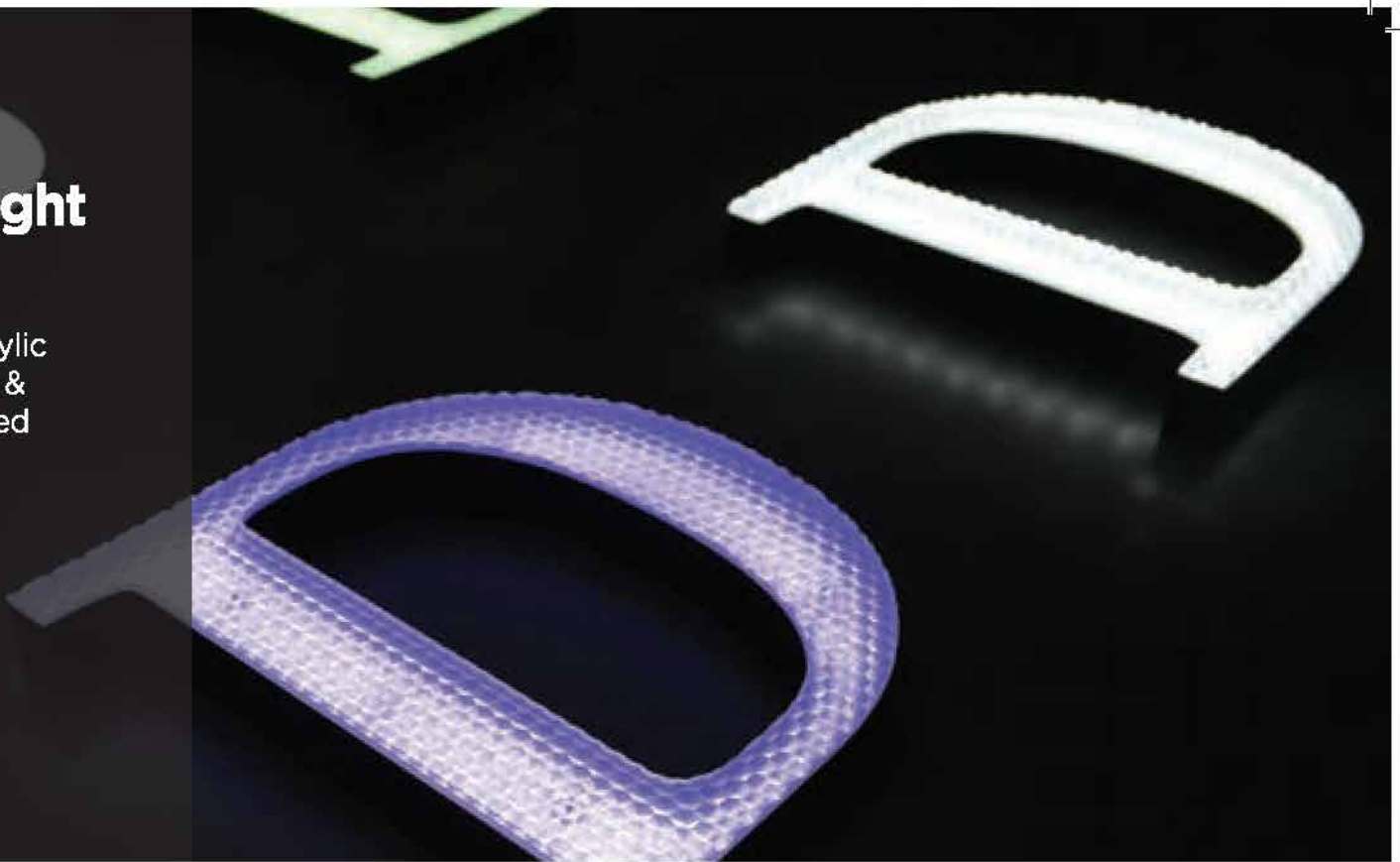

## Customized Color



## Light Color

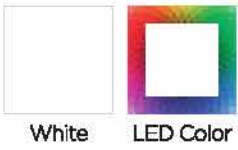

## Surface Material



**KL - SF - 01**

Daytime

Nighttime



**KL - SF - 02**

Daytime

Nighttime



**KL - SF - 03**

Daytime

Nighttime



**KL - SF - 04**

Daytime

Nighttime

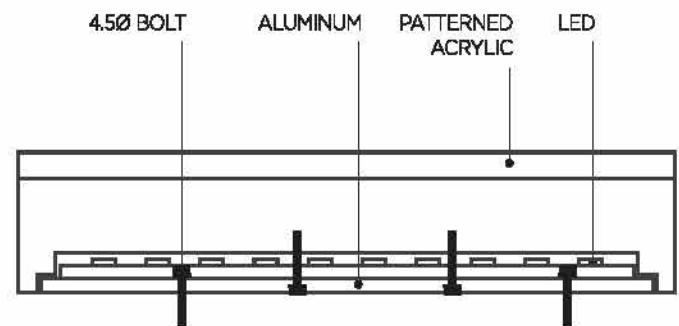
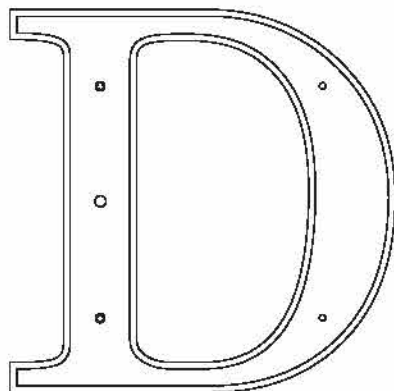
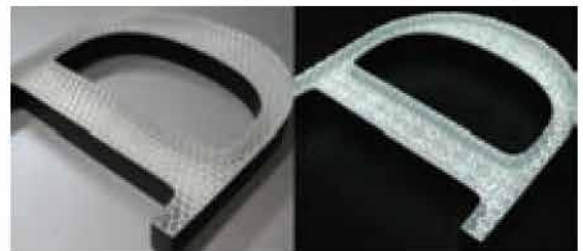

[Section Plan]

# Micro Perf. & Altuglas Light

1. Color changing block letter
2. Micro perforated metallic color changing letter  
-Patent pending

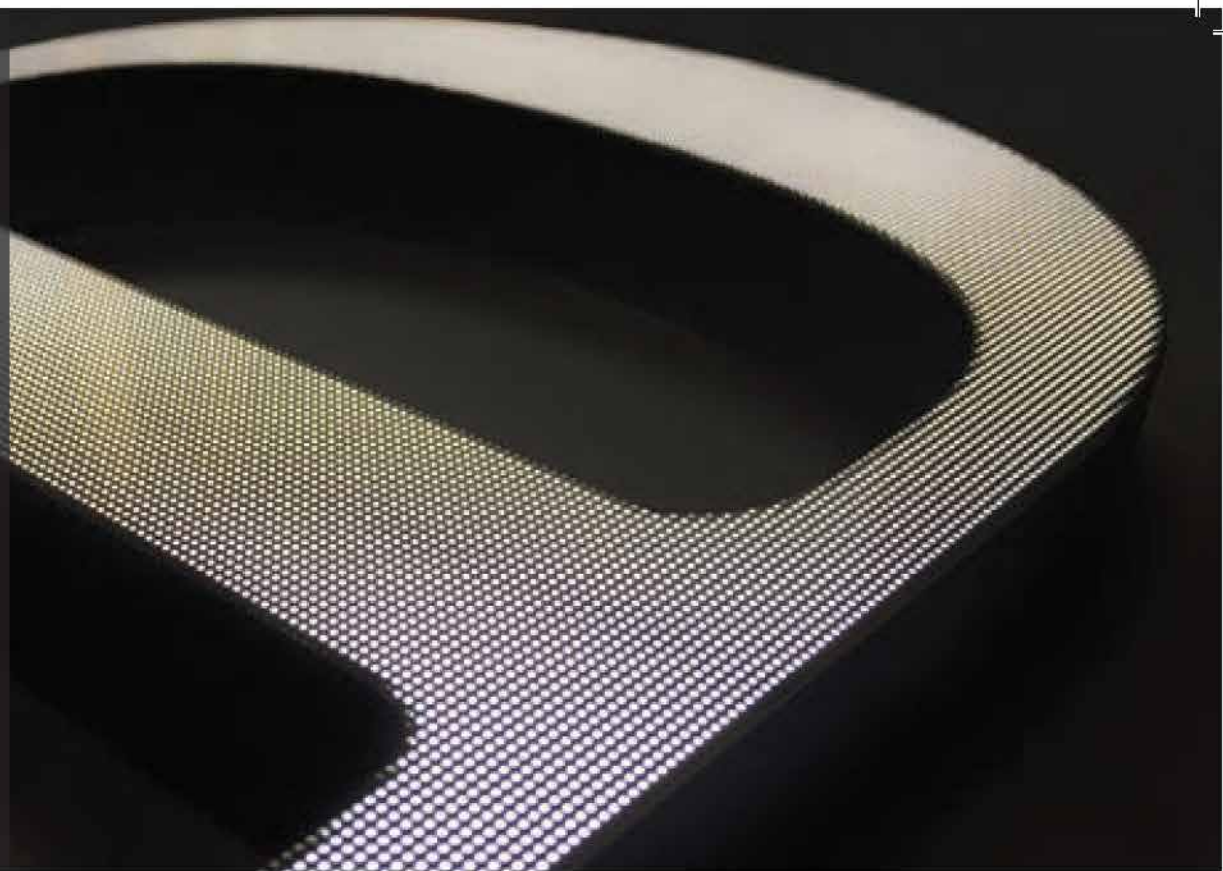

## Customized Color



## Light Color

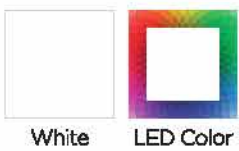

KL - A - 01

Daytime

Nighttime

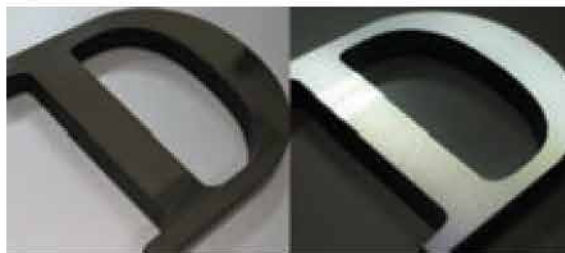

KL - A - 02

Daytime

Nighttime



KL - A - 03

Daytime

Nighttime



KL - A - 04

Daytime

Nighttime



## Top 1% Sign Science Unique Color Changing Acrylics

**Day**  
Black, Blue,  
Green, Red,  
Grey, And  
Custom Color

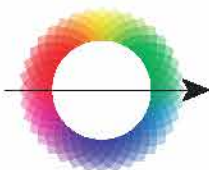

**Night**  
White  
or  
Custom  
LED Color

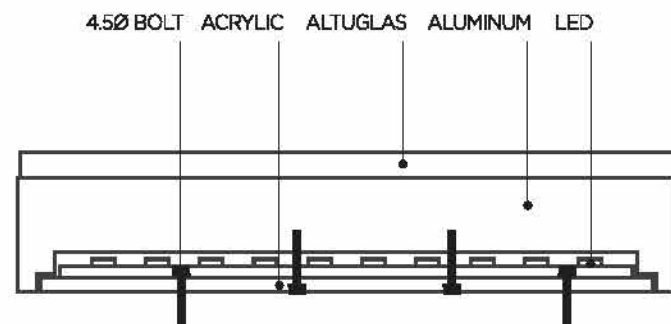

[Section Plan]

# Stainless Steel Micro Perf. Letter Light

- 1. Color changing block letter
- 2. Micro perforated stainless steel color changing letter

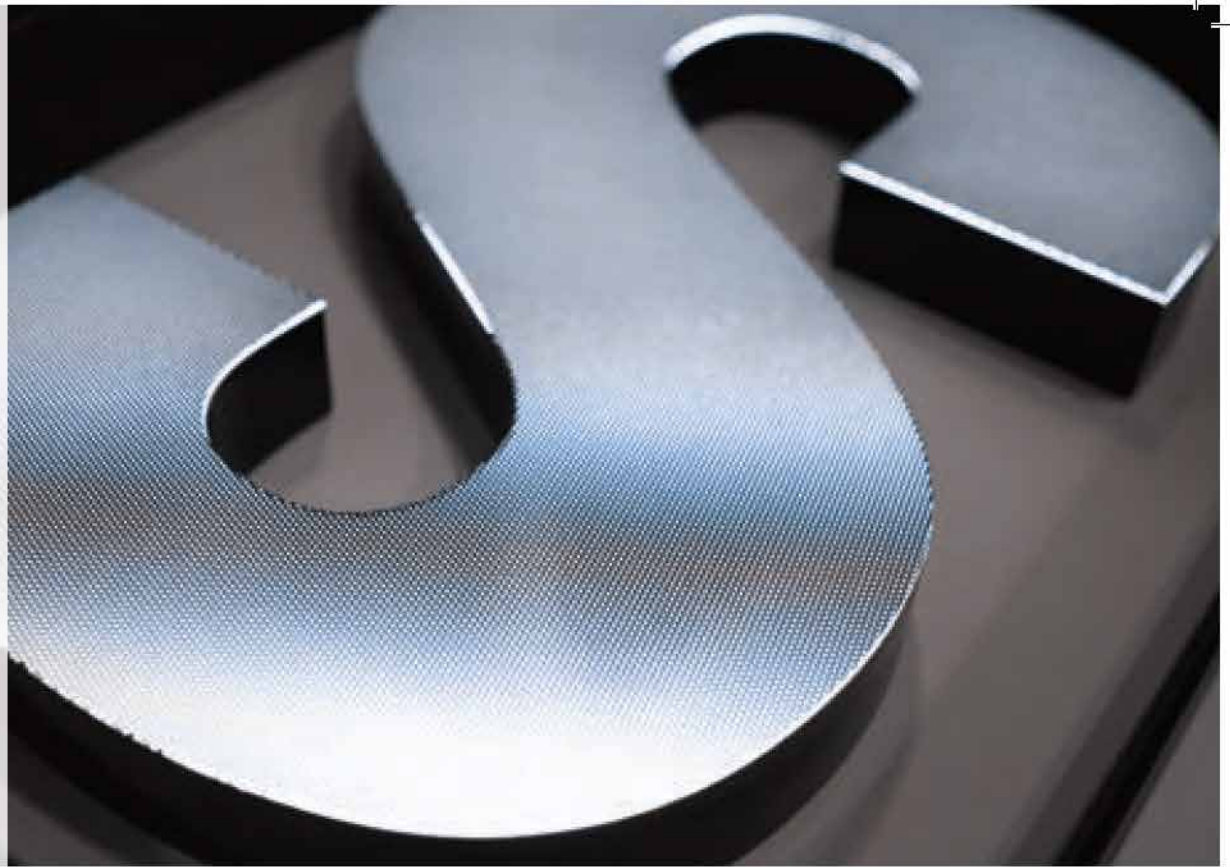

## Customized Color



## Light Color

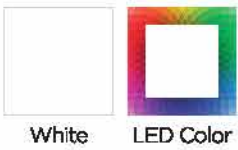

## Surface Material



Photo courtesy of 505 Design

Photo courtesy of 505 Design

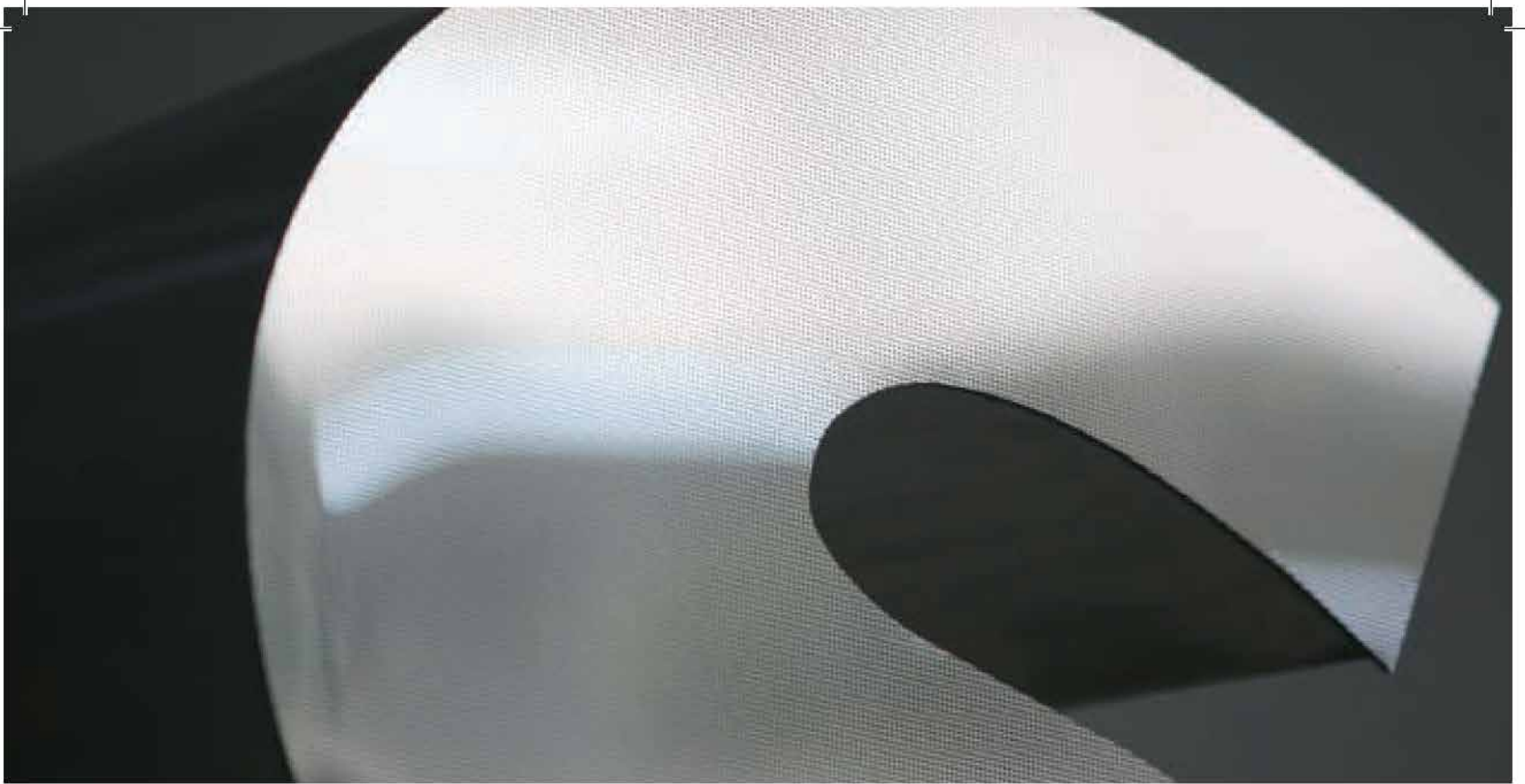

Customized Color



Light Color

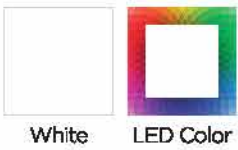

Surface Material



Daytime

Nighttime



Green

Daytime

Nighttime



Polished Steel

Daytime

Nighttime



Black

Daytime

Nighttime



# Curved Letter Light

Neon type curved  
Acrylic letters



## Customized Color



## Light Color

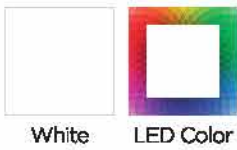

## Surface Material



KL - C - 02

Daytime

Nighttime

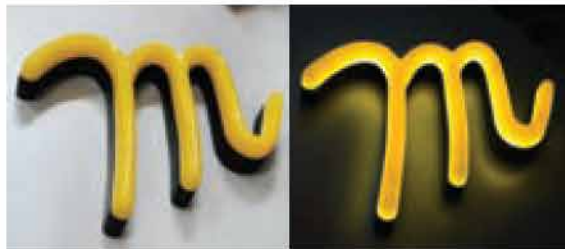

KL - C - 04

Daytime

Nighttime

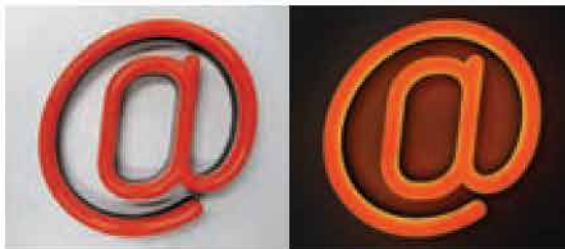

ACRYLIC R LED ABS

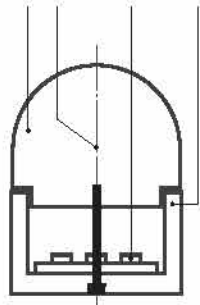

[Section Plan]

4.5Ø BOLT ABS ACRYLIC LED

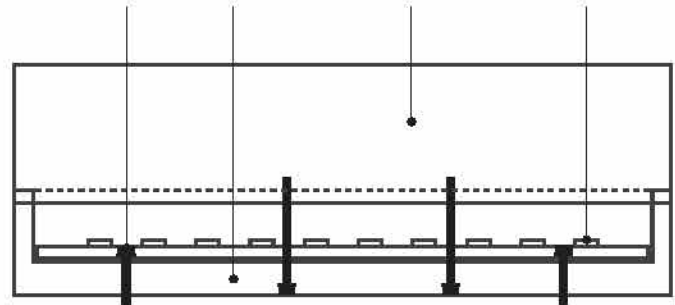

[Section Plan]



**Metallic Curved Letter Light**

3 available colors - Gold, Chrome, Chrome Black



**APEACH CAFE, KAKAO FRIENDS In Busan**

**THERE DESIGN PTY LTD in Sydney /Scaffad Australia PTY LTD**



# Vapor Deposition Letter Light

Color changing  
metalized  
acrylic letters



Surface Material



Light Color



White

LED Color

KL - H - 02

Daytime

Nighttime



KL - H - 03

Daytime

Nighttime

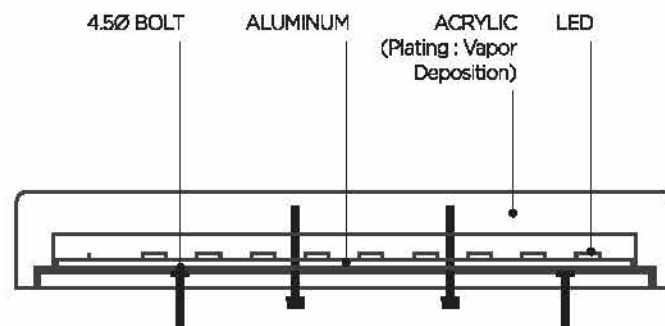
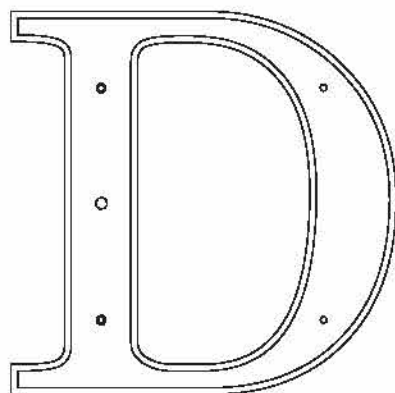

[Section Plan]

# Thin Letter Light

Minimum 1/8"  
Slim illuminated  
Acrylic letters



Surface Material



KL - T - 01

Daytime

Nighttime



Light Color



White

LED Color

Daytime

Nighttime

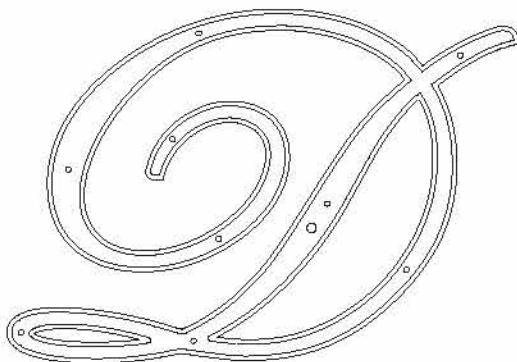

2mm



3mm



4mm



5mm

[Thickness Size]

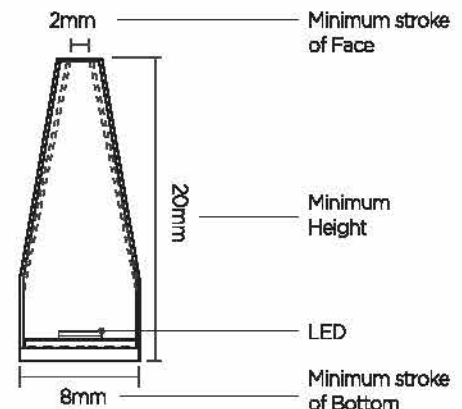

[Section Plan]

2016 Award Winning  
**BEST NEW PRODUCT**

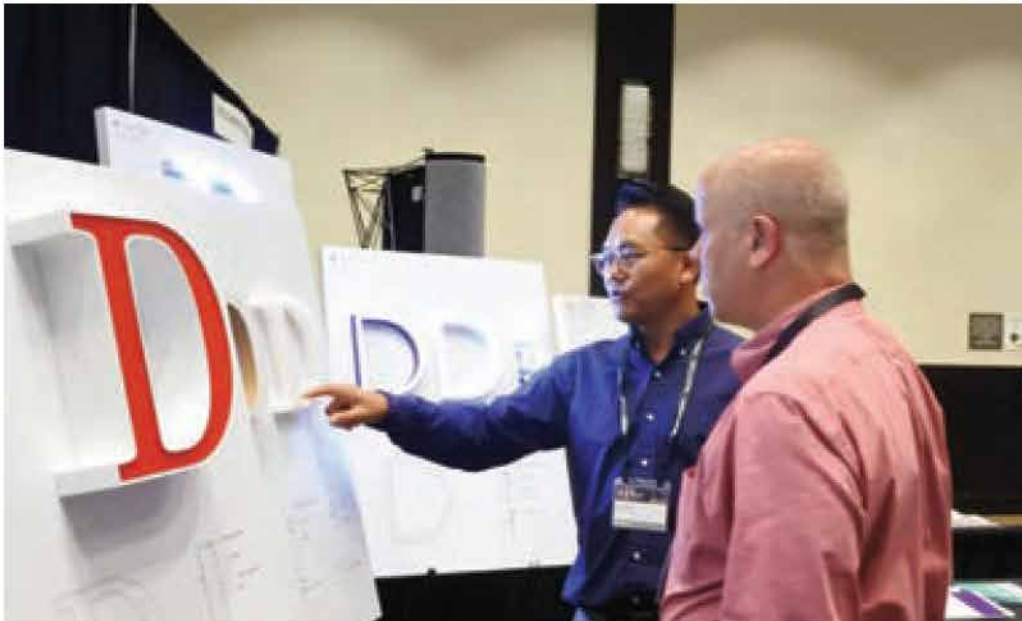

# What We Do

Total Solution for Signage System



# What We Do

Total Solution for Signage System



We can create Sign Designs to meet any new or existing need in the marketplace



Shopping Center | Commercial Complex



Hotel&Resort | Museum | Office



Public Space | Hospital



**We Design**

- Signage System Development
- Information Design
- Frame Design
- Location Plan

**We Develop**

- Signage Variation + Detail
- Designing work for manufacturing
- Technology Development

**We Make**

- First class exquisite signs of perfect workmanship



# Top 1% Sign Technology

preferred by Corporate Identity Programs Worldwide

## Our Mission

To motivate and support the design community and the sign manufacturing business by supplying the highest quality and most innovative acrylic products and materials available. Our technology creates lasting unique impressions which enhance the look and feel of your business.

### Our Locations

East Coast - Rye, NH

West Coast - Los Angeles, CA  
*Inventory of Acrylic and tailored LED's*

International - Seoul, Korea  
*Major manufacturing and Research and Development*

### Other Flex America Product Lines:

#### Digitally printable fabrics and banner vinyls

including 100% recyclable digital products for wallcovering, billboards, or outdoor advertising.

#### Digitally printable paper and card stock

including Stoplight blackout paper and polyester film laminated paperboard.



John McNair ■ [www.Flex-America.biz](http://www.Flex-America.biz)

**FLEX-AMERICA**  
Color Changing Channel Letter  
Block Channel Letter Signs

Address : 35 Brackett Road Rye, NH 03870

E-mail : [jmac12@comcast.net](mailto:jmac12@comcast.net)

Phone : (603)430-4432

Cell : (603)498-4662